



MANUAL
OPERATION



RECESS
POSSIBLE



EASY
TO BEND

FOREST KS[®] *Klick System*

Highly efficient hand drawn system for all types of medium and light weight draperies.
Quick installation with "Smart Klick" brackets for wall and ceiling applications.

THE WORLD
BEHIND
YOUR
CURTAINS

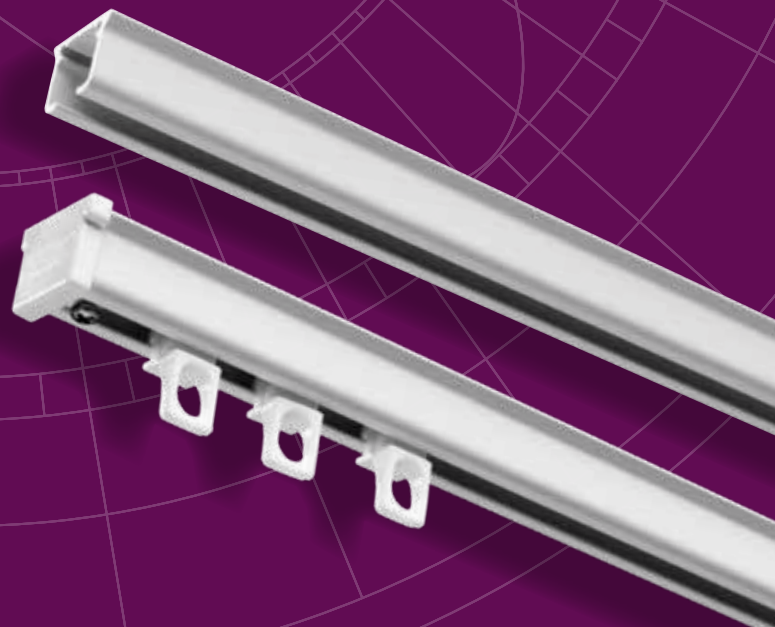

FOREST KS®



PRODUCT INFORMATION

- Highly efficient hand drawn system for all types of medium weight draperies.
- Quick installation with "Smart Klick" brackets for wall and ceiling applications with cover caps that conceal the screws.
- Bendable; it can be curved and reversed curved using a 10 cm (4") radius or continuous curve.
- Suitable for special window decoration as circular, arch and triangle window models.
- Heavy duty clickable carriers, UV-protected, for smooth and easy traversing.
Offset shape for straight hanging pleats.
- Can also be used for Forest Easyfold System and accordiafold drapery systems.
- Maximum fabric weight: 8 kg per meter (6 LBS per ft.).
- Colours available: white, gold, silver, brown, black, cream, beige, red, blue, yellow and green.
- Special colours: available on request.
- Available lengths: 3 meter (9'10"), 4 meter (13'1"), 5 meter (16'4"), 6 meter (19'8"), 7 meter (23').
- Track finish: chromated powder coated with a factory applied patented dry lubricant.

PROFILE

- Shown actual size 1:1.
- Aluminium Extrusion.
- Weight: 150 grams per meter (1.62 ounce per ft.).
- Dimensions: 14 mm x 20 mm (0,6" x 0,8").
- KS Recess: 12,5 mm x 21 mm (0,5" x 0,8")

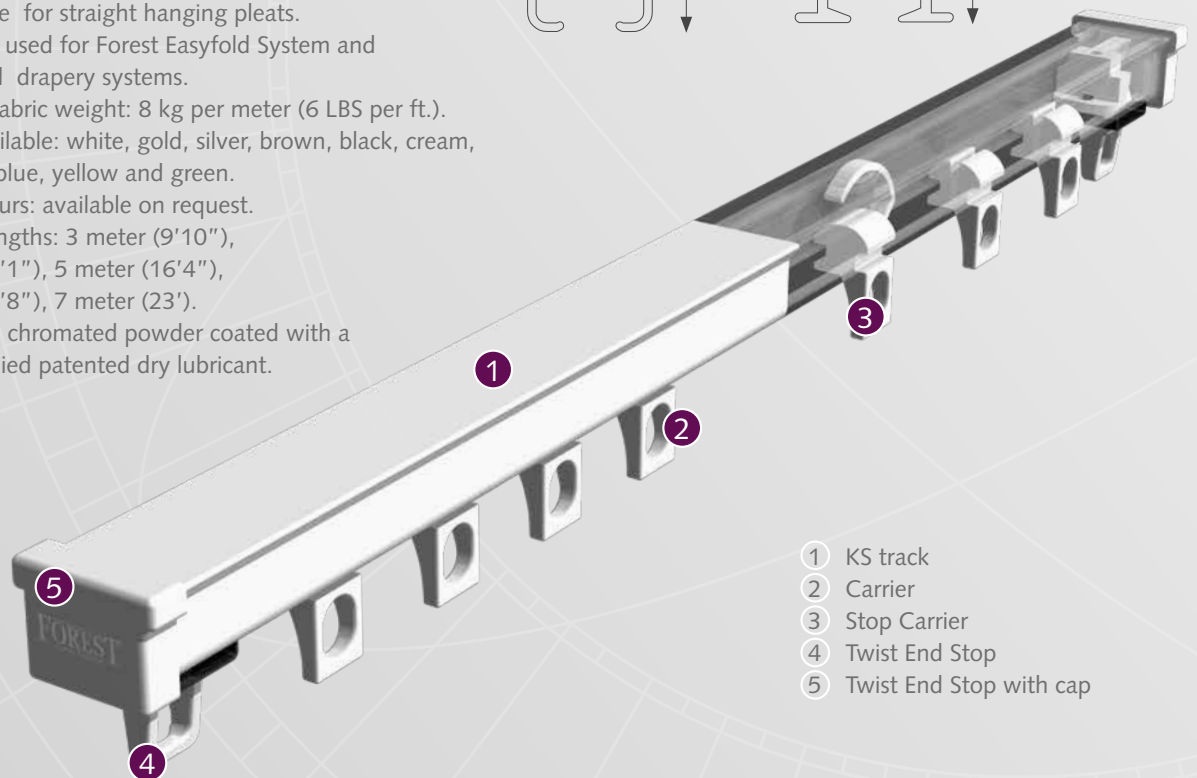
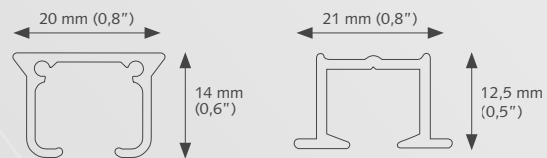

- 1 KS track
- 2 Carrier
- 3 Stop Carrier
- 4 Twist End Stop
- 5 Twist End Stop with cap



FOR USE IN

Hotels - offices - schools - healthcare - residences - boats - campers - planes or at any location where an efficient hand drawn system is required.

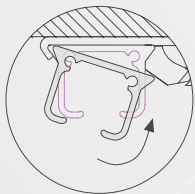

Easy installation
click - position - tighten

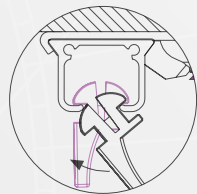

clickable carrier

25 mm (1")

BENDING / CURVING

The track can be curved and reversed curved using a 10 cm (4") radius. Additionally there is a curving possibility for special windows like arches, bows and circles. Bending instructions available on request.



SPECIAL WINDOW DECORATION

Special bends

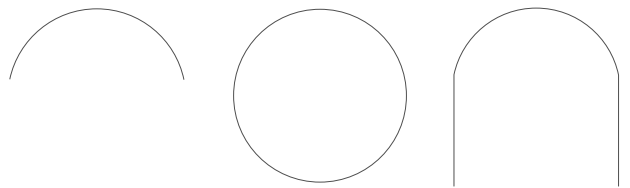

APPLICATIONS

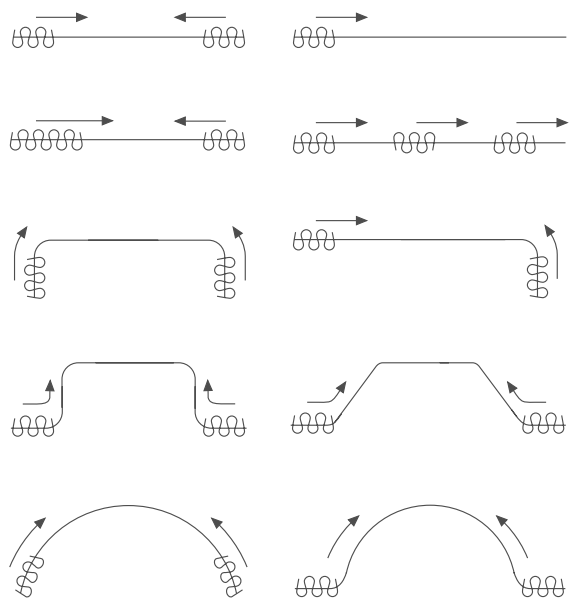

MOUNTING BRACKETS

Wall bracket

3,5 cm (1,4")

6 cm (2,4")

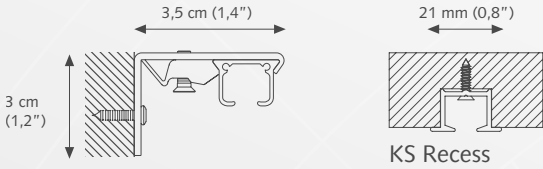

A) Min. 10 cm (4")

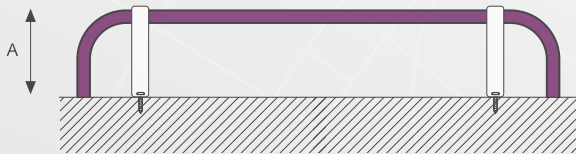

A) Min. 16 cm (6")

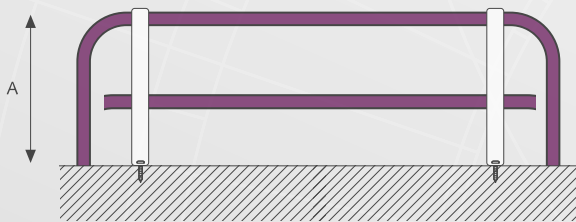

Other brackets are available. Brackets need to be placed every 60 cm (24").

Smart Click Ceiling Bracket

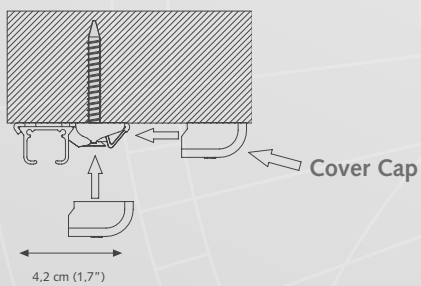

Aluminium Wall bracket single

A) 7,5 cm (3") B) 6,3 cm (2,5")

A) 10 cm (4") B) 8,8 cm (3,5")

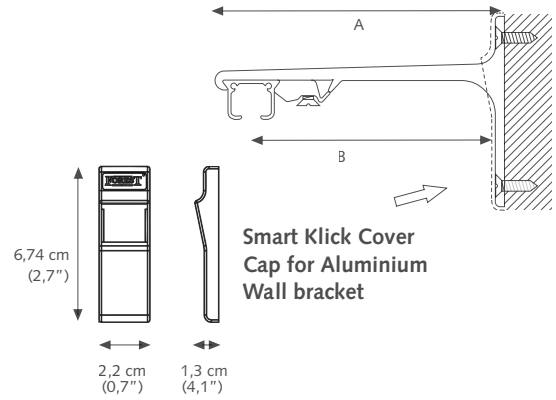

Aluminium Wall bracket double

A) 15 cm (6") B) 9,2 cm (3,6") C) 4,5 cm (1,8")

A) 20 cm (8") B) 9,2 cm (3,6") C) 9,5 cm (3,7")

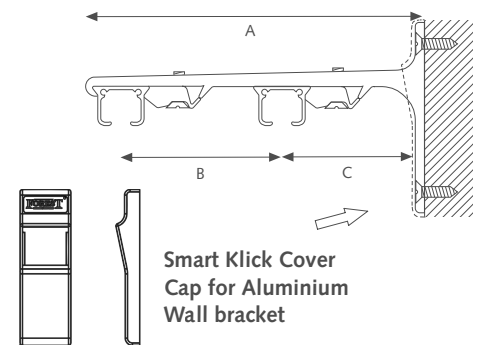





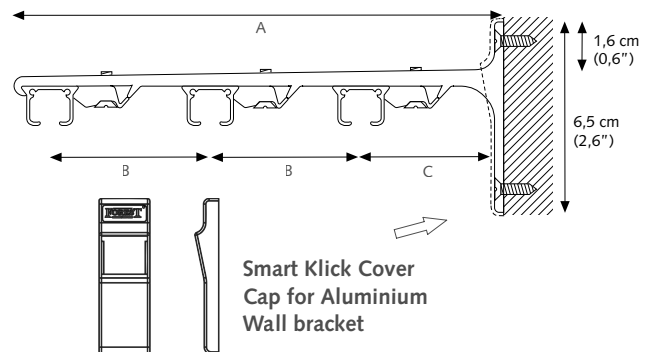

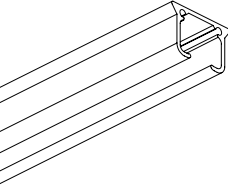

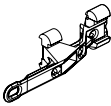
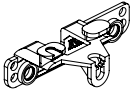
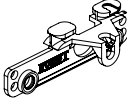

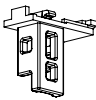
Aluminium Wall bracket triple

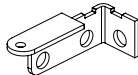

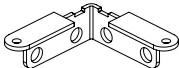
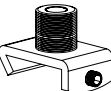

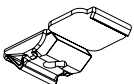
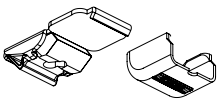
A) 25 cm (10") B) 9,3 cm (3,7") C) 5 cm (2")

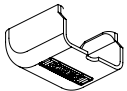
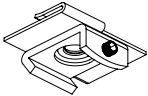
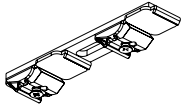
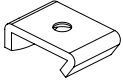
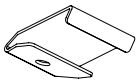
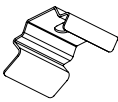

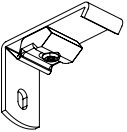
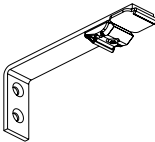
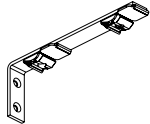
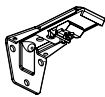
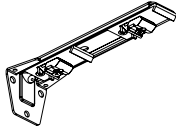
KS	KS RECESS	ARTICLE	PACKING UNIT	ART.NR			
●			KS TRACK WHITE Aluminium extrusion, powder coated, lubricated.	60 mtr/bundle 3 mtr (9'8") 80 mtr/bundle 4 mtr (13'1") 100 mtr/bundle 5 mtr (16'4") 120 mtr/bundle 6 mtr (19'8") 140 mtr/bundle 7 mtr (23')	1001001300 1001001400 1001001500 1001001600 1001001700		
			KS TRACK SILVER Aluminium extrusion, powder coated, lubricated.	120 mtr/bundle 6 mtr (19'8") 140 mtr/bundle 7 mtr (23')	1001003600 1001003700		
			KS TRACK GOLD Aluminium extrusion, powder coated, lubricated	120 mtr/bundle 6 mtr (19'8")	1001002600		
			KS TRACK BROWN Aluminium extrusion, powder coated, lubricated.	120 mtr/bundle 6 mtr (19'8")	1001005600		
			KS TRACK BLACK Aluminium extrusion, powder coated, lubricated.	120 mtr/bundle 6 mtr (19'8") 140 mtr/bundle 7 mtr (23")	1001006600 1001006700		
			KS TRACK Aluminium extrusion, powder coated, lubricated. off-white sand red blue yellow green	100 mtr/bundle 5 mtr (16'4") 5 mtr (16'4") 5 mtr (16'4") 5 mtr (16'4") 5 mtr (16'4") 5 mtr (16'4")	1001011500 1001012500 1001021500 1001022500 1001023500 1001024500		
			●		KS RECESS TRACK 6 Mtr (19'8") Aluminium extrusion, powder coated, lubricated and pre-drilled.	6 mtr/length white black	1031011600 1031016600
			●		MTS FLEXIBLE DUST STRIP. To seal the curtain track opening of the ks recess track during finishing phase.	100 mtr/roll	4518501000
			●		KS TRACK CONNECTORPIN STAINLESS 2X20 MM For a firm and seamless connection between two pieces of KS track.	10/box	9900000012
			●		KS/DS/CKS TRACK CONNECTOR	10/box white silver black	1018401010 1018403010 1018406010
●		KS PLASTIC TRACK CONNECTOR Can be inserted in the track, but still allows the carrier to run over.	50/box	1018400000			
●		KS RECESS CONNECTOR	50/box	1030000001			
●	●	KS AS CARRIER "Klickable", offset, constructed of UV-resistant plastic. 10 Carriers on a break-away strip. Can be clicked in after installation.	500/box white silver brown black sand	1010001000 1010003000 1010005000 1010006000 1010012000			
●	●	KS SYMMETRICAL CARRIER	500/box white	1010101000			
●		KS STOPCARRIER Prevents slide back, "klickable", constructed of UV-resistant plastic. Not in combination with KS plastic track connector & KS recess connector.	250/box white silver black	1010201000 1010203000 1010206000			
●	●	KS SHIRRTAPE CARRIER Carrier and hook in one "klickable" unit, constructed of UV-resistant plastic. For sew on drapery tape.	500/box white silver brown black	1010401000 1010403000 1010405000 1010406000			
●	●	KS AS CARRIER WITH METAL HOOK "Klickable", offset, with stainless steel hook, constructed of UV-resistant plastic. For use with grommets.	100/box white brown	1010501000 1010505000			

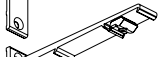
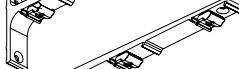
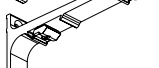
KS	KS RECESS	ARTICLE	PACKING UNIT		ART.NR
●		 MASTER CARRIER/REVERSIBLE Reversible overlap carrier, "Klicks" into track, constructed of UV-resistant plastic. For straight track only. Colours: 01.	25/box		1010301000
●	●	 EASYFOLD PLASTIC MASTER UNDERLAP The Plastic Master is reversible. There are also snaps on the back of the Master.	25/box	white transparent silver black	4815201010 4815201000 4815203010 4815206010
●	●	 EASYFOLD PLASTIC MASTER STRAIGHT The Plastic Master is reversible. There are also snaps on the back of the Master.	25/box	white transparent silver black	4815101010 4815101000 4815103010 4815106010
●	●	 KS TWIST ENDSTOP "Twists" into track, with metal plate, constructed of UV-resistant plastic.	100/box	white silver	1016201000 1016203000
●		 KS TWIST ENDSTOP WITH CAP "Twists" into track, with metal plate and end cap, constructed of UV-resistant plastic.	100/box	white silver black	1016301000 1016303000 1016306000
	●	 KS RECESS PUNCH ENDSTOP To cover the slot	100/box	white black	1060601000 1060606000
●		 KS ENDCAP + SCREW SHORT To be used for a single draw curtain.	100/box	white silver black	1006001000 1006003000 1006006000
●		 EASYFOLD KS UNIVERSAL ENDCAP WITH SCREW To be screwed with an Easyfold carrier, made of UV-resistant plastic.	100/box	white silver brown black	4816001000-A 4816003000-A 4816005000 4816006000-A
●		 KS WALL SUPPORT RIGHT 2,5 x 5 cm (1"x2") return plate, powder coated.	25/box	white silver	1016601000 1016603000
		 KS WALL SUPPORT LEFT 2,5 x 5 cm (1"x2") return plate, powder coated.		white silver	1016701000 1016703000
●		 STRAIGHT RETURN R/L 5 x 5 cm (2 x 2") reversible return plate, powder coated.	25/box	white brown	1016501000 1016505000
●		 SUSPENSION BRACKET CLIP FOR MTS CEILING SUPPORT To be used in combination with the Suspension Ceiling Bracket	50/box		1016901000
●		 KS CEILING BRACKET Slides onto the track, powder coated. Regular duty.	100/box	white silver brown black sand	1018001000 1018003000 1018005000 1018006000 1018012000
●		 KS CEILING BRACKET WITH SLOT Slides onto the track, powder coated. Regular duty.	100/box	white silver brown black off-white sand	1018101000 1018103000 1018105000 1018106000 1018111000 1018112000
●		 KS SMART KLICK CEILING BRACKET "Klicks" onto track, powder coated.	100/box	white silver brown black	1018201000 1018203000 1018205000 1018206000
●		 KS SMART KLICK CEILING BRACKET INCL COVER CAP "Klicks" onto track, powder coated.	100/box	white silver brown black	1018201001 1018203001 1018205001 1018206001

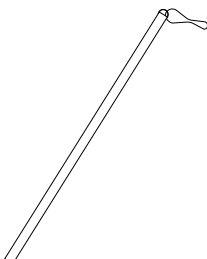
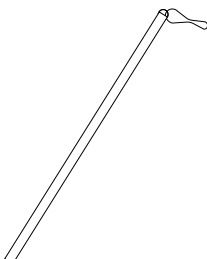
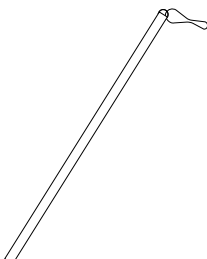
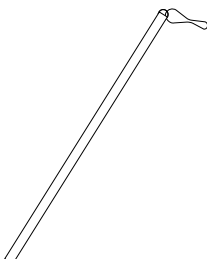
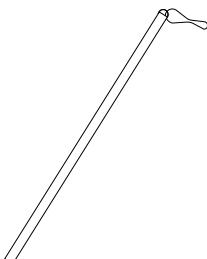
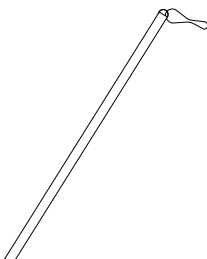
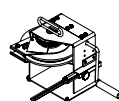
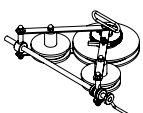
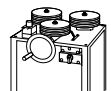
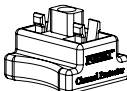
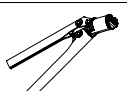
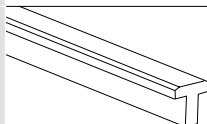
KS	KS RECESS	ARTICLE	PACKING UNIT		ART.NR
●		 <p>KS SMART KLICK COVER CAP Fits on Smart Klick Wall and Ceiling bracket.</p>	100/box	white grey brown black	1019201000 1019203000 1019205000 1019206000
●		 <p>SUSPENDED CEILING BRACKET, METAL For installation on to a suspended ceiling. The track can be fixed in any angle.</p>	25/box		4519001000
●		 <p>KS SMART KLICK CEILING BRACKET DOUBLE LONG Distance between two tracks: 90 mm (3,5")</p> <p>KS SMART KLICK CEILING BRACKET DOUBLE SHORT</p>	30/box	white silver black	1018601000 1018603000 1018606000 1018611000
●		 <p>FSS MOUNTING BRACKET For concealed installation or ceiling installation in narrow spaces. Heavy Duty.</p>	100/box		7160001000
●		 <p>KS CEILING SPLICE BRACKET For ceiling installation only, powder coated.</p>	50/box	white silver brown black	1018501000 1018503000 1018505000 1018506000
●		 <p>KS KLICK-ON CEILING BRACKET WHITE For concealed installation without visible brackets, light weight use only.</p>	100/box		1018301000
●		 <p>MTS SUSPENSION Ceiling Bracket Length: 10 cm (4") - 1 m (3,3') 1 m (3,3') - 1,5 m (4,9')</p>	1/each		4518201000 4518201500
●		 <p>KS SMART KLICK WALL BRACKET 3,5 cm "Klicks" onto track, powder coated. One screw attachment. For light weight use only.</p> <p>KS SMART KLICK WALL BRACKET 6 cm "Klicks" onto track, powder coated. One screw attachment. For light weight use only.</p> <p>KS SMART KLICK WALL BRACKET 7,5 cm</p>	50/box	white silver black	1020201035 1020203035 1020206035 1020201060 1020203060 1020206060 1020201075 1020203075 1020206075
●		 <p>KS SMART KLICK WALL BRACKET 10 cm</p> <p>KS SMART KLICK WALL BRACKET 12,5 cm</p> <p>KS SMART KLICK WALL BRACKET 15 cm</p> <p>KS SMART KLICK WALL BRACKET 20 cm</p> <p>KS SMART KLICK WALL BRACKET 25 cm</p> <p>KS SMART KLICK WALL BRACKET 30 cm</p>	20/box 20/box 15/box 15/box 10/box 10/box	white silver white silver white silver white silver white silver white silver	1020201100 1020203100 1020201125 1020203125 1020201150 1020203150 1020201200 1020203200 1020201250 1020203250 1020201300 1020203300
●		 <p>KS SMART KLICK WALL BRACKET DOUBLE For light weight use only.</p>	15/box	10 cm 15 cm 20 cm	1020601100 1020601150 1020601200
●		 <p>KS ADJUSTABLE WALL BRACKET, SINGLE</p>	100/box	white silver	1020801115 1020803115
●		 <p>KS ADJUSTABLE WALL BRACKET, DOUBLE</p>	50/box	white silver	1020801195 1020803195

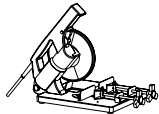
KS	KS RECESS	ARTICLE	PACKING UNIT		ART.NR
●		 KS SMART KLICK ALUMINIUM WALL BRACKET 7,5 cm	20/box	white silver	1020301075 1020303075
		 KS SMART KLICK ALUMINIUM WALL BRACKET 10 cm	20/box	brown black	1020305075 1020306075
		 KS SMART KLICK ALUMINIUM WALL BRACKET 15 cm	15/box	white silver	1020301100 1020303100
		 KS SMART KLICK ALUMINIUM WALL BRACKET 20 cm	15/box	black white	1020306100 1020301150
		 KS SMART KLICK ALUMINIUM WALL BRACKET 25 cm	10/box	silver brown black	1020303150 1020305150 1020306150
				white silver black	1020301200 1020303200 1020306200
				white silver	1020301250 1020303250
●		 COVER CAP FOR KS SMART KLICK ALUMINIUM WALL BRACKET	50/box	white silver black	1021301000 1021303000 1021306000
●	●	 KS FLICKSTICK FIBERGLASS	50/box	92 cm 122 cm	1065101092 1065101122
		 KS FLICKSTICK TRANSPARENT	50/box	152 cm 92 cm	1065101152 1065102092
		 KS FLICKSTICK WHITE ALUMINIUM	50/box	122 cm 152 cm	1065102122 1065102152
		 KS FLICKSTICK SILVER ALUMINIUM	50/box	92 cm 122 cm	1065111092 1065111122
		 KS FLICKSTICK BLACK ALUMINIUM	50/box	152 cm 92 cm	1065111152 1065111202
		 KS FLICKSTICK ANTIQUE ALUMINIUM	50/box	122 cm 152 cm	1065113092 1065113122
				92 cm 122 cm	1065116092 1065116122
				152 cm 92 cm	1065116152 1065119092
				122 cm 152 cm	1065119122 1065119152
●	●	 COMPACT BENDING TOOL For KS / KS RECESS / CKS	1/each		1050000000
					1050100000
					1030000000
●		 CONTINUOUS CURVER Add on tool for the Compact Bending Tool. Designed to create continuous curves and arches in any radius. Includes KS bending strip. For KS and CKS Track only.	1/each		1060200000
●	●	 ELECTRIC POWERED BENDER Available in 230V or 115V To create continuous curves and arches minimum radius 50 cm (20")	1/each		1060500000
	●	 CHANNEL PROTECTOR with bit	1/set	purple	1070600000
	●	 KS RECESS PUNCH PINCHER	1/each		1060600000
●	●	 KS BENDING STRIP For Compact Bending Tool. KS RECESS BENDING STRIP Length of strip: 60 cm (23,6"). 2 strips	1/each		1060100000
			1/each		8500000000-A 1030000000-D
			1/each		1060300000 8500000010
●	●	 KS/CKS BENDING WHEELS For Electric Powered Bender. Complete set of 3 wheels.	1/set		1060700000
●	●	 ELECTRIC POWERED RAILCUTTER 230 Volt EU	1/each		1061100000
					1061200000
					1061200000