



MANUAL
OPERATION



HOTEL
TRACK

FOREST CS[®] *Contract System*

Heavy duty hand drawn curtain track system for medium and heavy draperies.

THE WORLD
BEHIND
YOUR
CURTAINS



FOREST CS®



PRODUCT INFORMATION

- Heavy duty hand drawn system for medium and heavy draperies.
- Bendable; it can be curved and reversed curved using a 20 cm (8") radius or continuous curve.
- Heavy duty clickable carriers - 10 carriers on a breakaway strip - UV protected. Can also be used with ball bearing carriers.
- Ideal for use with overlap masters and batons which can be mounted behind or in front of draperies.
- Can also be used for the Forest Wave System (FES) and accordiafold drapery systems.
- Maximum fabric weight: 15 kg per mtr (11,25 LBS per ft).
- Colours available: white, black, silver and brown.
- Track finish: chromated powder coating with a factory applied patented dry lubricant.
- Available lengths: 3.66 m (12'), 4.27 m (14'), 4.88 m (16'), 6.10 m (20')
- Limited lifetime warranty.

- 1 CS Track
- 2 Carrier
- 3 Master Carrier R/L Overlap
- 4 Master Carrier R/L Underlap
- 5 Ball bearing carrier
- 6 Endcap with screw

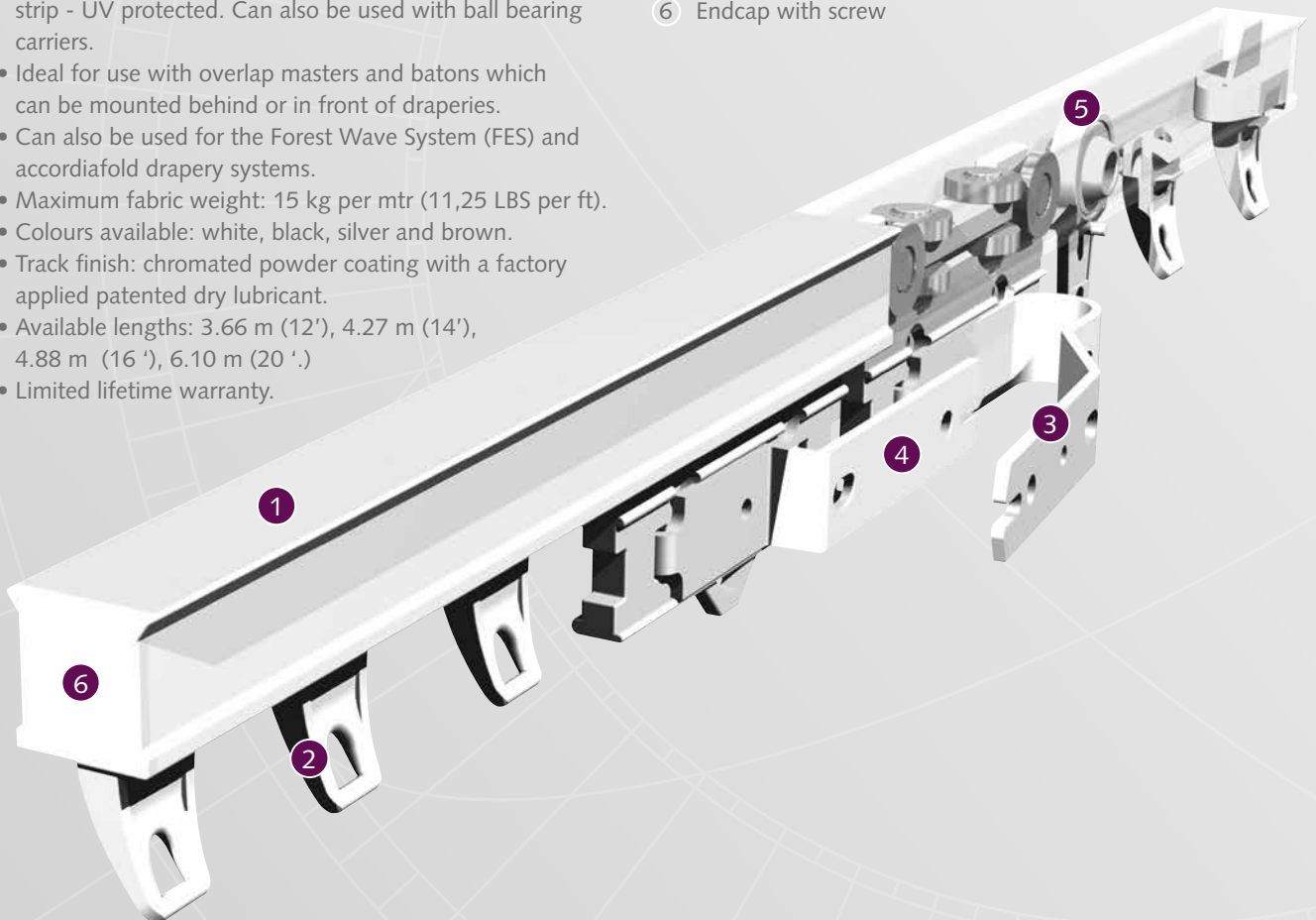



BENDING / CURVING

The track can be curved and reversed curved using a 20 cm (8") radius. Continuous curving is also possible with the electrical bending tool.



PROFILE

- Weight: 235 gram p. mtr (2.53 ounce - ft).
- Aluminium Extrusion
- Dimensions: 20 mm x 20 mm (0,8" x 0,8")

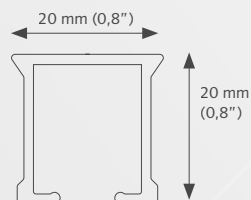

FOR USE IN

Hotels - Motels - offices - schools - healthcare residential or at any location where a heavy duty hand drawn system is required.

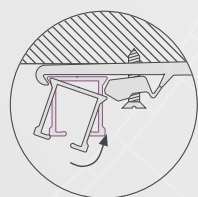

Easy installation
click - position - tighten

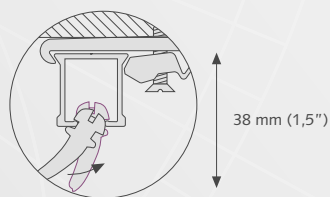

clickable carrier

APPLICATIONS

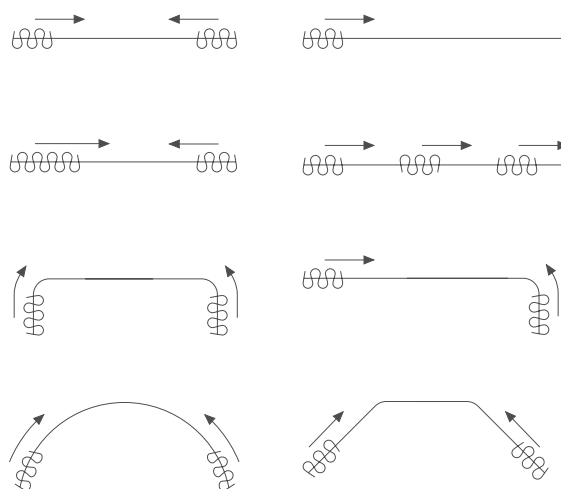

CLICK-ON STIFFNER

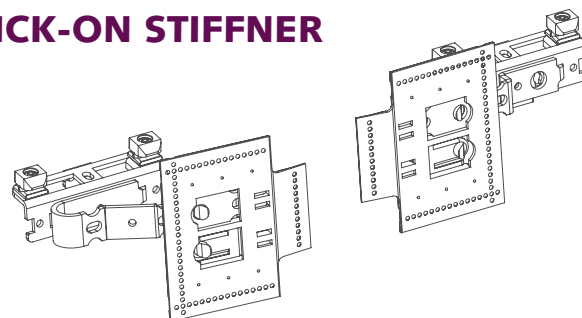

MOUNTING BRACKETS

Smart Klick Ceiling bracket

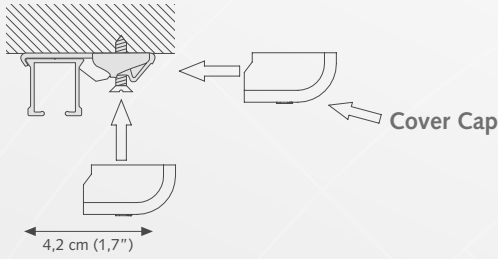

A) Min. 20 cm (8")



A) Min. 20 cm (8")

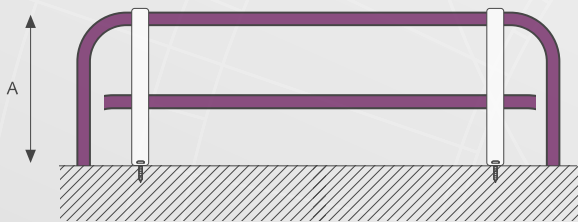

Other brackets are available. Brackets need to be placed every 60 cm (24").

SK Aluminium Wall bracket single

- A) 7,5 cm (3") B) 6,3 cm (2,5")
 A) 10 cm (4") B) 8,8 cm (3,5")

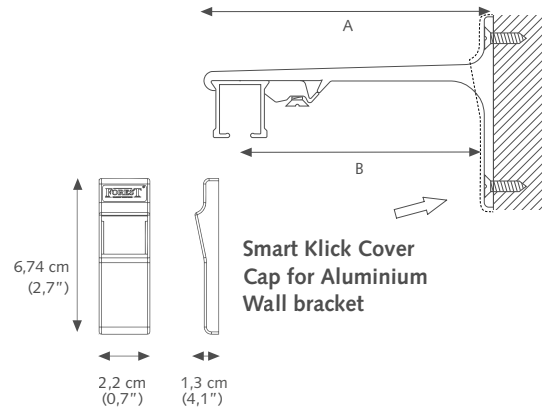

SK Aluminium Wall bracket double

- A) 15 cm (6") B) 9,2 cm (3,6") C) 4,5 cm (1,8")
 A) 20 cm (8") B) 9,2 cm (3,6") C) 9,5 cm (3,7")

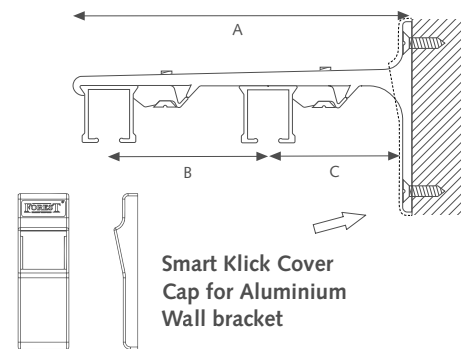





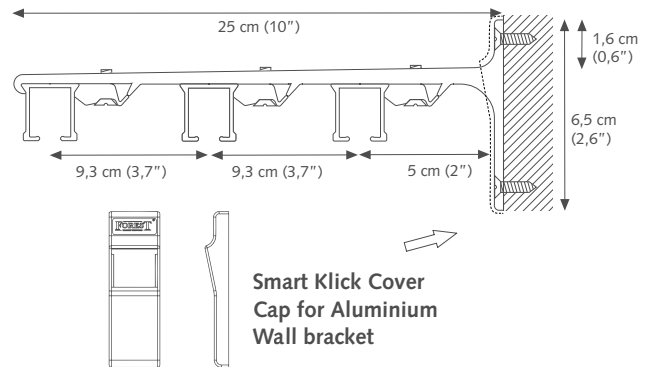

SK Aluminium Wall bracket triple

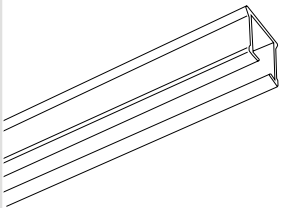
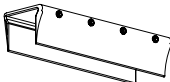
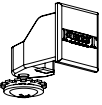
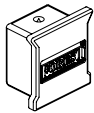
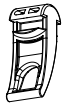

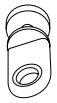

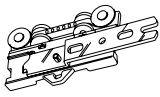
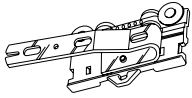
- A) 25 cm (10")

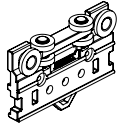
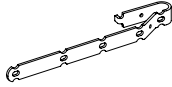
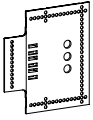
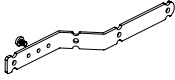
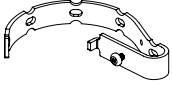
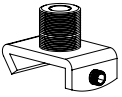
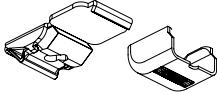
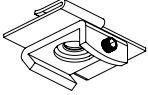
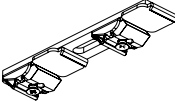

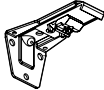
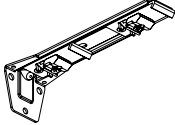

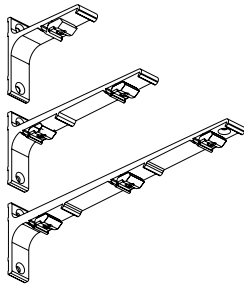
Brackets need to be placed every 50 - 60 cm (20"), depending on fabric weight.

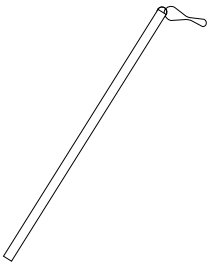
CS	ARTICLE	PACKING UNIT		ART.NR	
●		CS TRACK WHITE Extruded aluminium chromated, powder coating, factory lubricated.	10/bundle	3,66 meter (12') 4,27 meter (14') 4,88 meter (16') 6,10 meter (20')	2501001366 2501001427 2501001488 2501001610
		CS TRACK SILVER Extruded aluminium chromated, powder coating, factory lubricated	10/bundle	4,88 meter (16') 6,10 meter (20')	2501003488 2501003610
		CS TRACK BROWN Extruded aluminium chromated, powder coating, factory lubricated.	10/bundle	4,88 meter (16') 6,10 meter (20')	2501005488 2501005610
		CS TRACK BLACK Extruded aluminium chromated, powder coating, factory lubricated.	10/bundle	6,10 meter (20')	2501006610
●		CS/CCS/FMS TRACK CONNECTOR Used to make a solid connection between two pieces of track.	10/box	white silver black	2518401000 2518403000 2518406000
●		CS ENDCAP UNIVERSAL LONG WITH SCREW	100/box	white silver black	2516400000 2516403000 2516406000
●		CS ENDCAP UNIVERSAL SHORT WITH SCREW	100/box	white silver black	2516401001 2516403001 2516406001
●		CS / CCS AS CARRIER "Clickable", offset, constructed of UV-resistant plastic. 10 Carriers on a break-away strip. Can be clicked in after	250/box	white silver black	2510101000 2510103000 2510106000
●		CS STOPCARRIER Clickable.	100/box	white silver	2510201000 2510203000
●		CS / CCS CARRIER AS WITH HOOK Clickable.	100/box	white silver	2510501000 2510503000
●		CS ECONOMY SLIDE Can turn in the track.	500/box 500/box	white black	2510601000 2510606000
●		CS BALL BEARING CARRIER 20MM CS BALL BEARING CARRIER 20MM	100/box	white black	2512000000 2512006000
CS BALL BEARING CARRIER 16MM SMALL CS BALL BEARING CARRIER 16MM SMALL			white black	2512000016 2512006016	
CS BALL BEARING CARRIER 25MM LARGE				2512100000	
●		CS UNDERLAP CARRIER R/L	25/box	white	2514600000
●		CS OVERLAP CARRIER R/L	25/box	white	2514700000

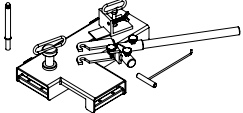
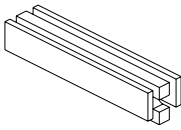
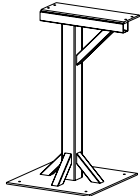
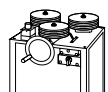
CS	ARTICLE	PACKING UNIT	ART.NR
	CS MASTER CARRIER BASE R/L WHITE	25/box	white 4814500000
	PROLONGED OVERLAP ARM 150MM R/L FOR CLICK-ON STIFFNER	15/box	9500001010
	STIFFNER "CLICK-ON"	15/box	5116001001
	Z-ARM UNIVERSAL 175MM R/L	15/box	white 9500001030
	FMS EASYFLEX CURVED ARM R/L WHITE	15/box	Pc. 5135901020
	SUSPENSION BRACKET CLIP FOR MTS CEILING SUPPORT	50/box	Pc. 1016901000
	SMART KLICK CEILING BRACKET INCL COVER CAP "Klicks" onto track, powder coated.	100/box	white silver brown black 1018201001 1018203001 1018205001 1018206001
	SUSPENDED CEILING BRACKET, METAL For installation on to a suspended ceiling. The track can be fixed in any angle.	25/box	4519001000
	SMART KLICK CEILING BRACKET DOUBLE LONG Distance between two tracks: 90 mm (3,5") SMART KLICK CEILING BRACKET DOUBLE SHORT	30/box	white 1018601000 1018611000
	MTS SUSPENSION Ceiling Bracket Length: 10 cm (4") - 1 m (3,3') 1 m (3,3') - 1,5 m (4,9')	1/each	4518201000 4518201500
	KS ADJUSTABLE WALL BRACKET, SINGLE	100/box	white silver 1020801115 1020803115
	KS ADJUSTABLE WALL BRACKET, DOUBLE	50/box	white silver 1020801195 1020803195

CS	ARTICLE	PACKING UNIT	ART.NR	
	SMART KLICK ALUMINIUM WALL BRACKET 7,5 cm	20/box	white silver brown black	1020301075 1020303075 1020305075 1020306075
	SMART KLICK ALUMINIUM WALL BRACKET 10 cm	20/box	white silver black	1020301100 1020303100 1020306100
	SMART KLICK ALUMINIUM WALL BRACKET 15 cm	15/box	white silver brown black	1020301150 1020303150 1020305150 1020306150
	SMART KLICK ALUMINIUM WALL BRACKET 20 cm	15/box	white silver black	1020301200 1020303200 1020306200
	SMART KLICK ALUMINIUM WALL BRACKET 25 cm	10/box	white silver black	1020301250 1020303250 1020305250
	COVER CAP FOR SMART KLICK ALUMINIUM WALL BRACKET	50/box	white silver black	1021301000 1021303000 1021306000
	FLICKSTICK FIBERGLASS	50/box	92 cm 122 cm	1065101092 1065101122
	FLICKSTICK TRANSPARENT	50/box	152 cm 92 cm	1065101152 1065102092
	FLICKSTICK WHITE ALUMINIUM	50/box	122 cm 152 cm	1065102122 1065102152
	FLICKSTICK SILVER ALUMINIUM	50/box	92 cm 122 cm 152 cm	1065111092 1065111122 1065111152
	FLICKSTICK BLACK ALUMINIUM	50/box	202 cm 92 cm	1065111202 1065113092
	FLICKSTICK ANTIQUE ALUMINIUM	50/box	122 cm 152 cm	1065113122 1065113152
	FLICKSTICK ANTIQUE ALUMINIUM	50/box	92 cm 122 cm 152 cm	1065116092 1065116122 1065116152
	VELCRO HOTEL PROFILE Inside frame fix, to reduce light leakage in combination with Looptape	120 mtr/bundle		3581601600
	VELCRO HOTEL PROFILE Looptape	25 mtr/roll		3816202020
	CONTRACT BENDING TOOL BASIC (without bending wheel)	1/each		2560000000
	CS/CCS/FMS BENDING WHEEL	1/each		2561000000
	CS BENDING STRIPS For CS track, length: 90 cm (35,4")	1/set		8500000001
	FOR CS ELECTRIC POWERED BENDER. Length 7 meter (23').	1/set		5160600000
	BENDING STAND Stand for contract bending tool	1/each		2560800000
	ELECTRIC POWERED BENDER Available in 230V or 115V To create continuous curves and arches minimum radius 50 cm (20")	1/each		1060500000

CS	ARTICLE	PACKING UNIT	ART.NR
●	 <p>KS/CKS BENDING WHEELS For Electric Powered Bender. Complete set of 3 wheels.</p>	1/set	1060700000
●	 <p>ELECTRIC POWERED RAILCUTTER 230 Volt EU</p> <p>REPLACEMENT BLADE For electric powered railcutter.</p>	1/each	1061100000 1061200000
●	 <p>FOREST LUBRICANT To lubricate components during assembly.</p>	1/each	5109010000